



The clean solution

M-iQ PERFECT IS NOT ENOUGH



M-iQ. A TOTALLY NEW DEFINITION OF CLEANING TECHNOLOGY.



PERFE

NOTHING LEFT TO CHANGE WHEN EVERYTHING COUNTS.

M-iQ. HOLISTIC CLEANING TECHNOLOGY FOR PEOPLE AND THE ENVIRONMENT.

You do not need more water and energy to clean hygienically; you need more thought – this is MEIKO's philosophy. We are continually developing cleaning technologies but are striving not only to advance technology; we have the bigger picture in mind – people, nature and resources. We unequivocally demand sustainable cleaning technology for a clean world. We strive to integrate apparently contradictory demands into a coherent concept. Absolute hygiene and safety on the one hand, frugal use of water and energy on the other. Awareness of costs as well as economical technology and the use of the most modern intelligent technologies. A Herculean task. MEIKO has taken on this challenge, covering all essential aspects of cleaning technology. **The result: M-iQ. A new definition of cleaning technology.**



ACTION

INTELLIGENCE



M-iQ. Intelligent cleaning technology that sets new standards. Improved **hygiene**, **safety**, **efficiency** and **ecology**.

M-iQ AIRCONCEPT

Optimal energy efficiency

Conformity to DIN standards without compromise

No need for a direct exhaust air connection

M-iQ FILTER

Revolutionary filter system

Active food waste particle removal

Maximum efficiency of the washing process

- > Intelligent exhaust air management
- > Revolutionary filter system

M-iQ EFFECT



M-iQ. SUPERIOR IN EVERY DETAIL

**M-iQ. IN
HARMONY
WITH ITSELF
AND THE
WORLD**





CLEAN RIGHT FROM THE START

M-iQ FEEDING SECTION CLEANING

Hygienic cleaning for MEIKO starts at the infeed section. Food particles are continuously flushed away with a powerful wave action. Like an enormous cleansing torrent.

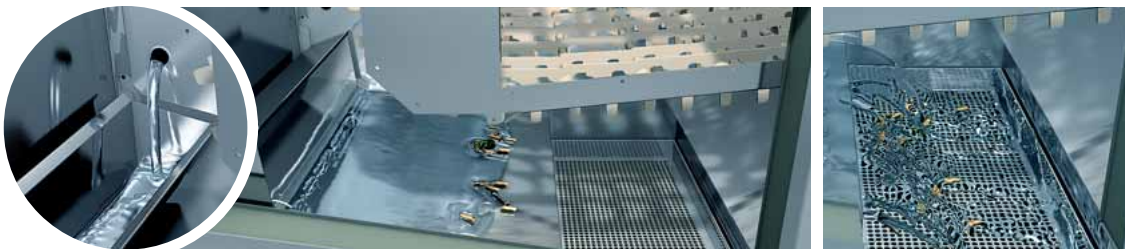
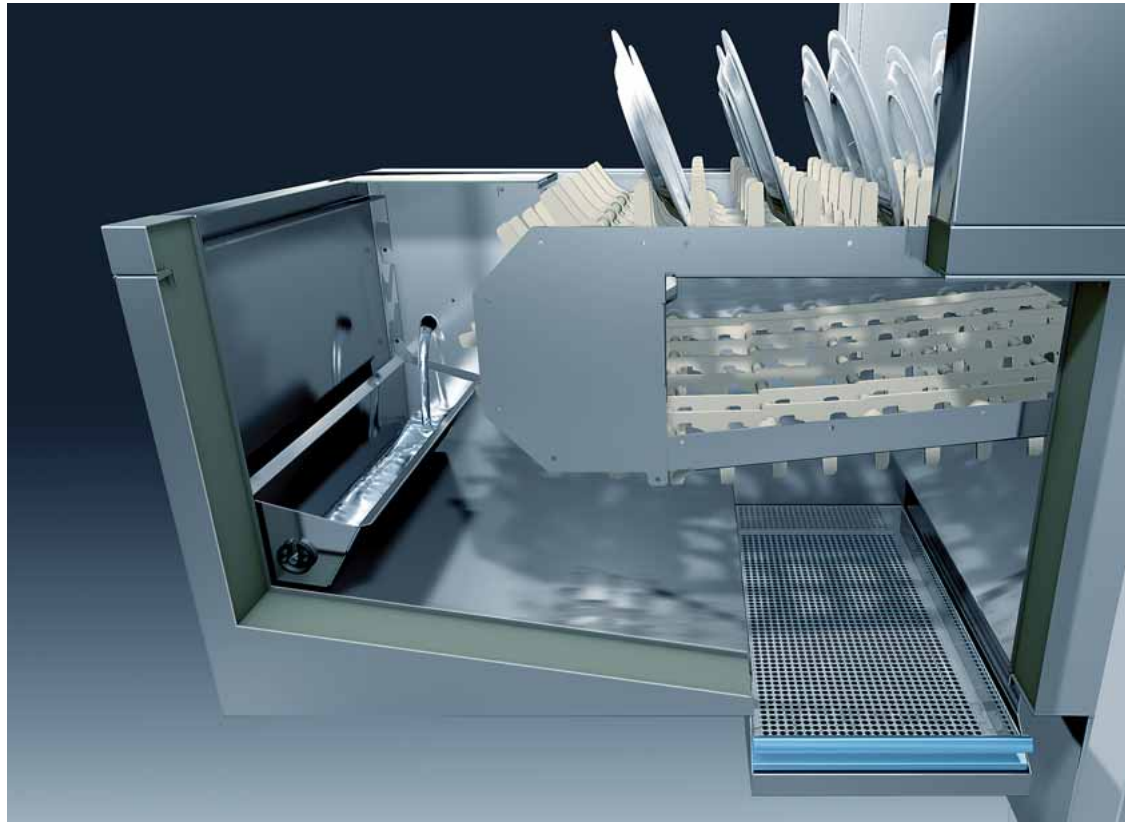

Wash water is collected and flushes the food particles into the collection filter using a powerful wave action.

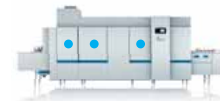

30% MORE CLEANING POWER

M-iQ WASHING DYNAMICS

MEIKO's well-known high cleaning capacity has been significantly increased and optimised in the M-iQ. Its washing dynamics achieve levels which have not previously been possible. Maximum cleaning power with a third less consumables and energy consumption. A clean achievement.



M-iQ WASHING DYNAMICS
 High pressure washing-
 reduced consumables consumption
 New computer designed wash nozzles
 for optimal spray pattern geometry
 30% improved cleaning power

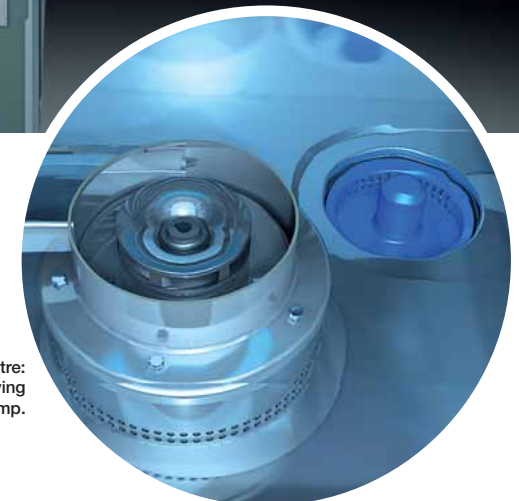

The power centre:
 the self-emptying
 stainless steel wash pump.



MORE THOUGHT INSTEAD OF MORE WATER

THE M-iQ FILTER

At the heart of the M-iQ is the M-iQ filter – ground breaking efficiency combined with state of the art engineering, used in this application for the very first time. The M-iQ filter introduces a revolutionary system. Filtered food particles are actively removed from

the wash water during the cleaning process. First the filter collects the food particles from the water and then rinses any residual food particles cyclically from the tank. Additional fresh water or detergent is not needed.

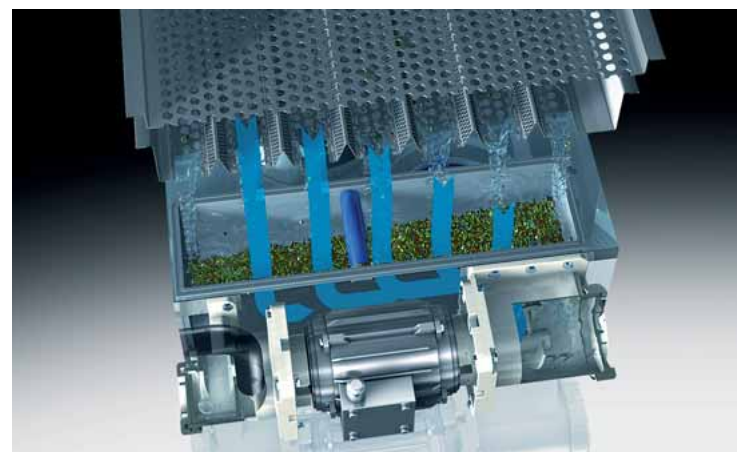

In a continual process, any food soil is filtered out by a coarse filter and a self-cleaning fine filter.

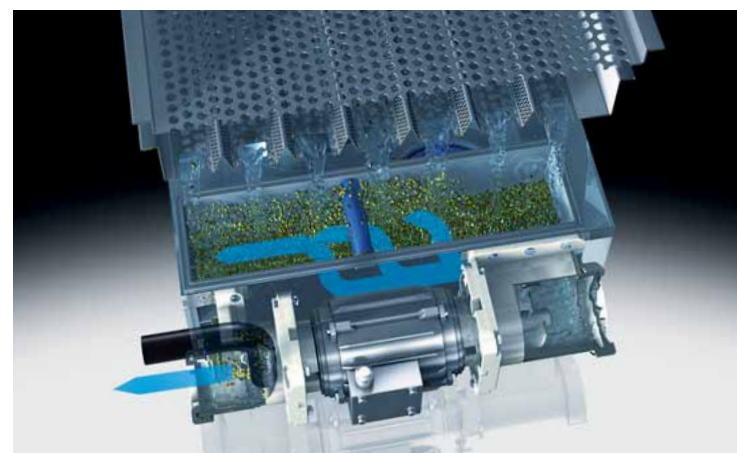

New: the cyclical back-flushing removes the collected food particles from the tank – a revolutionary MEIKO innovation.

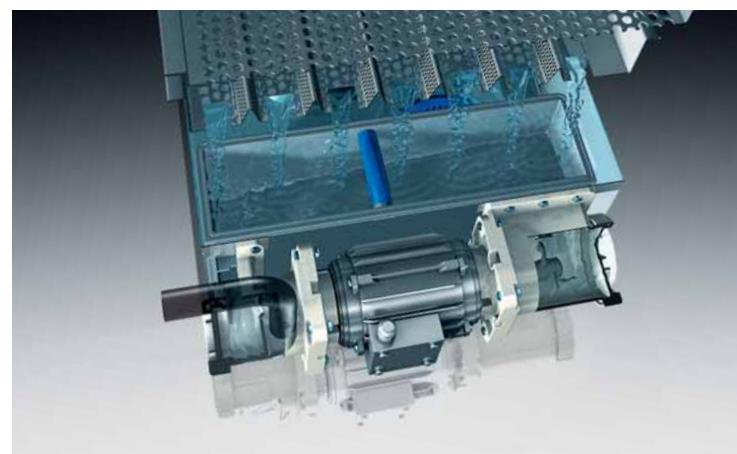

The effect: the food particles are gone and the wash water can be used more effectively - without additional top ups.

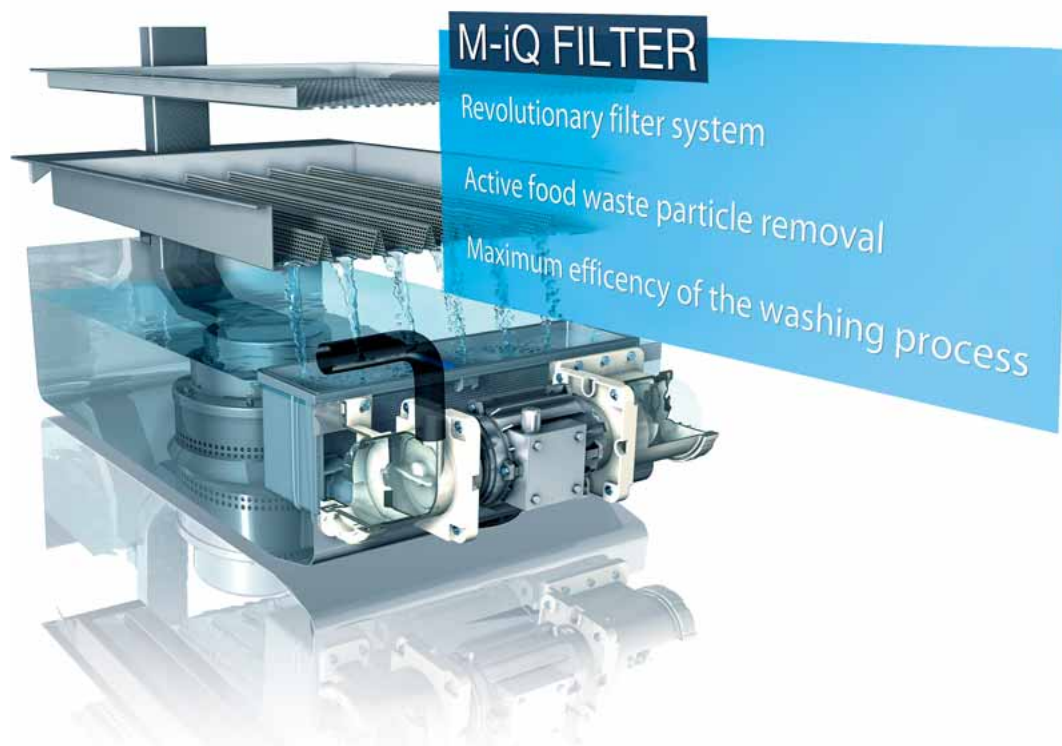

M-iQ FILTER
 Revolutionary filter system
 Active food waste particle removal
 Maximum efficiency of the washing process

Triple-layered system:
 coarse filter, fine filter and M-iQ filter unit

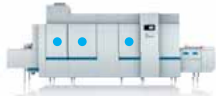

NO HOT AIR

THE M-iQ AIR CONCEPT

The M-iQ provides reliability in cleaning and hygiene – a revolutionary air conducting system makes it possible. It is absolutely compliant with DIN standards, providing the highest degree of energy efficiency. The M-iQ air system means innovative air conduction. The air is conducted from the hot clean area against the working direction to the cool feeding section.

This prevents contamination of the clean area while retaining valuable heat energy for rinsing. It also reduces energy consumption to very low levels. The M-iQ heat recovery module often makes a direct exhaust air connection unnecessary.



Cool. The flow of heat is diverted; exhaust air and steam cool off and the M-iQ gains new heating energy.



M-iQ AIR CONCEPT
 Optimal energy efficiency
 Conformity to DIN standards without compromise
 No need for a direct exhaust air connection



A NEW LEVEL OF HYGIENE

M-iQ TANK MANAGEMENT

Uniquely, the new type of M-iQ filter works in every tank – together they make the perfect team. The show-stopper: The system works against the working direction – the clean area stays truly clean and the residual particles collect far away from the hygienically clean washware.

We do not even leave the water level of the tank to chance. Using the M-iQ filter we transfer water into the adjacent tank or into any tank that needs it, depending on its operational status.



FINALLY A CLEAN BALANCE

THE M-iQ ENERGY CONCEPT

No washing system yet has ever cleaned as gently and efficiently as the M-iQ. Valuable heat is actively recovered in the M-iQ heat module as a means of harnessing energy while at the same time cooling the exhaust air that flows through it.

This intelligent distribution provides an optimal energy balance – and ensures the best climate in the wash-up area.

Everything is taken care of with M-iQ rinsing technology.

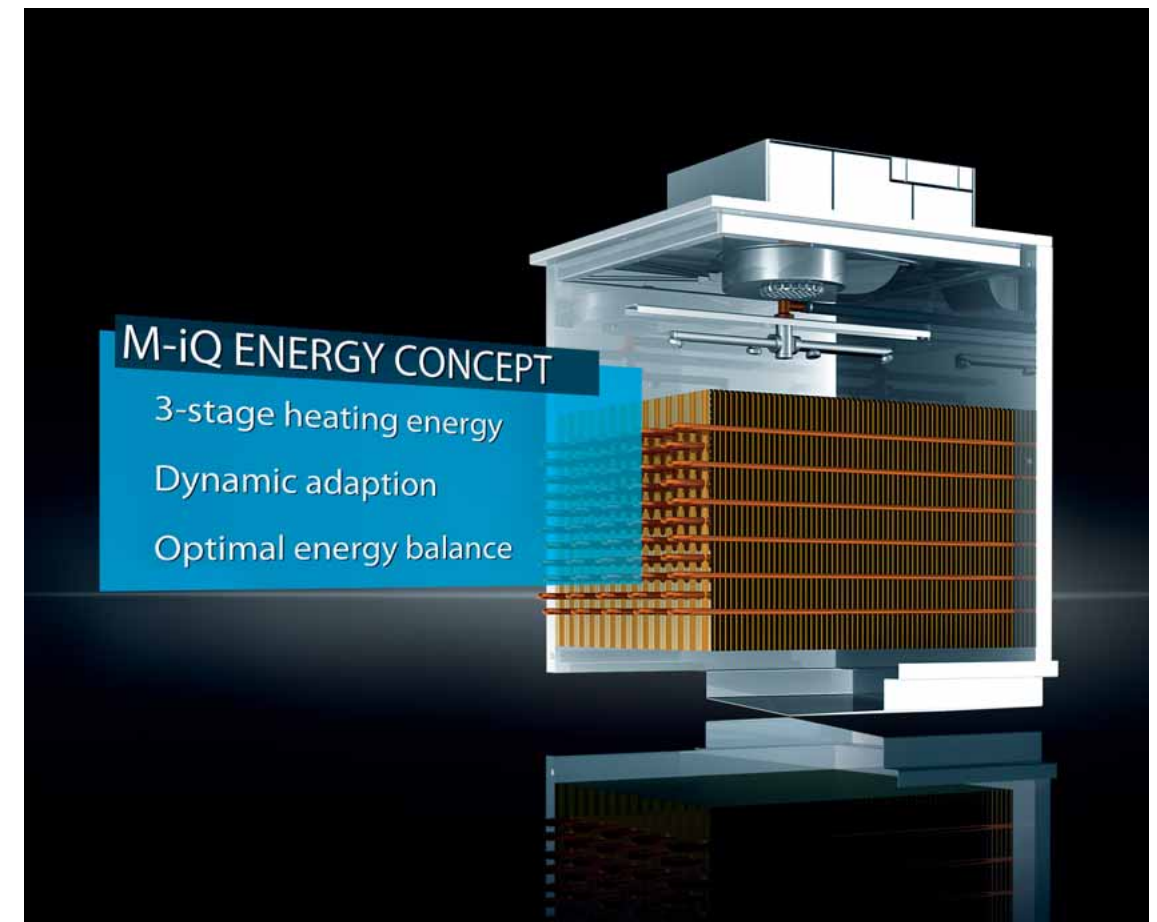

Three effects in one concept – perfection. Heat recovery lowers energy consumption and keeps the exhaust air volume and temperature at optimal levels.



BLUEVISION

THE M-iQ CONTROL CONCEPT

The brain of the M-iQ is the BlueVision control software. All cleaning operations can be controlled from the CC-Touch glass display. Clever: only the menu items that can be used at any one time are displayed, doing away with non required

information. The self-explanatory handling with a large TFT colour graphic display ensures reliable operation. Every user group (kitchen management, cleaning staff, service, etc.) can call up extensive information from the memory or record it.

Authorised persons can easily take control and systematically optimise functions. Since the M-iQ colour display is capable of very high resolutions, supplementary information such as operating instructions, spare parts lists, contact data, etc. can be displayed directly on the CC touch.

Optionally the M-iQ provides access into the machines online (CC Insight) or by a handheld device (CC Log).

M-iQ. Washing with IQ – for perfect vision.



Clearly arranged and always visible: the M-iQ TFT colour display



A wireless login into the machine control unit provides for the transfer and storage of all system-relevant data to a Palm device within seconds. This ensures that changes to operating processes, analyses and diagnoses are possible at any time

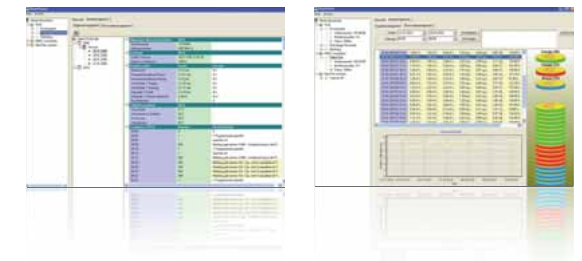

All system-relevant data, functions and operating processes are stored and displayed by the integrated KMM communication module. Operating conditions are analysed and diagnosed, and can be easily changed using the computer as necessary.



SPOTLESSLY CLEAN, ALMOST ON IT'S OWN

THE M-iQ SELF-CLEANING

Even at the end of a long day of cleaning, the M-iQ still thinks actively. With the tank water available the M-iQ simply cleans itself. Any food soil is discharged through the M-iQ filter with just one filling of the pumped final rinse. This continues in cycles until the machine is empty. Now only the few areas that are

clearly blue need to be cleaned manually. But after the previous automatic cleaning this is easier and can be done more thoroughly, quickly and reliably than ever before. In other words: no problem – it's taken care of.



The intelligent self-cleaning programme of the M-iQ requires little work, providing for increased economic efficiency.

Step by step the tank water cleans the M-iQ, an intelligent cascade system.



FITS LIKE A GLOVE – ALWAYS

THE M-iQ PLATFORM CONCEPT

Whatever the system designs for the use of the M-iQ might look like, modular M-iQ technology can be used in all situations. The M-iQ fits anywhere. The available conveyor widths and heights provide for optimal use of space and efficiency. In other words: the M-iQ is at home everywhere.

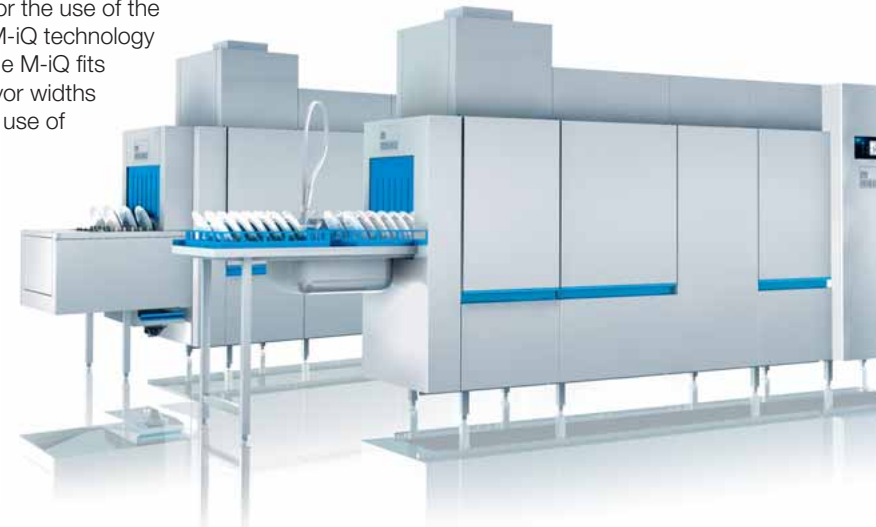

The modular design of the M-iQ permits optimal adaptation to individual customer needs and room conditions.

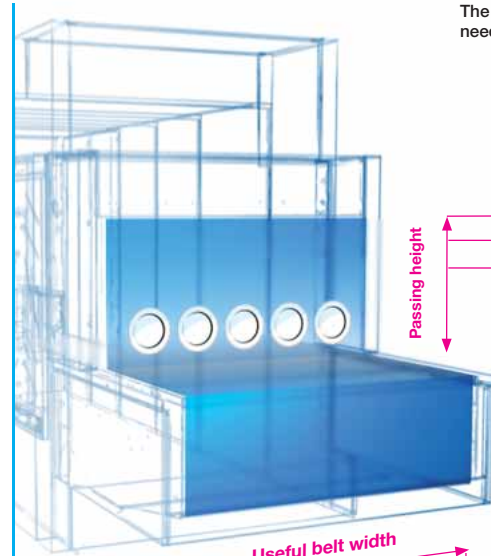

705 mm
585 mm
465 mm

Passing height

Useful belt width

570 mm
750 mm
980 mm
1,220 mm

Whether basket or conveyor transport, the M-iQ fits perfectly with a selection of conveyor dimensions and useful belt widths.



M-iQ. AUTOMATIC BASKET ON BASKET

M-iQ. CONTINUOUS CLEANLINESS

M-iQ. CULTURED BASKET TRANSPORT

MEIKO provides the perfect solution for every need. MEIKO basket machines provide convenience and optimal adaptability to conditions in the wash-up area.

The M-iQ basket transport machine follows in this tradition. The M-iQ plays an active role whenever there is a wide variety of dishware and cutlery that needs to be cleaned according to diverse schedules. Numerous basket configurations and ergonomic handling make work easier for employees.

THE RIGHT CHOICE

Technology serves people; MEIKO serves people and the environment. M-iQ sets new standards with its hygienic cleaning methods, economic operation and extremely low consumption levels. Basket after basket.



M-iQ. BELT TRANSPORT PERFECTED FURTHER

MEIKO has extensive experience in the construction of belt conveyor machines. The M-iQ is yet another example of MEIKO's series of successes.

The M-iQ belt conveyor machine cleans dishes, cups and trays quickly and hygienically. User-friendliness and high performance make the M-iQ a favourite amongst employees and employers alike. The M-iQ sensibly combines ecology and economy. Everyone benefits, operators and the environment

UNIVERSAL ABILITY

Uncomplicated handling and well-fitting belt shapes makes the M-iQ an all-purpose machine. Various feeding possibilities and finger widths as well as numerous special belts for hotels, cafeterias and hospitals leave nothing to want.



STANDARD M-iQ MODELS

EXAMPLES FROM THE M-iQ RANGE.

Two examples of basket transport machines, S & M and two examples of belt conveyor machines L & XL. One width that takes care of all the requirements in the standard range.

INVESTMENT AND RUNNING COSTS COMPARED

M-iQ cleaning technology- present cleaning technology

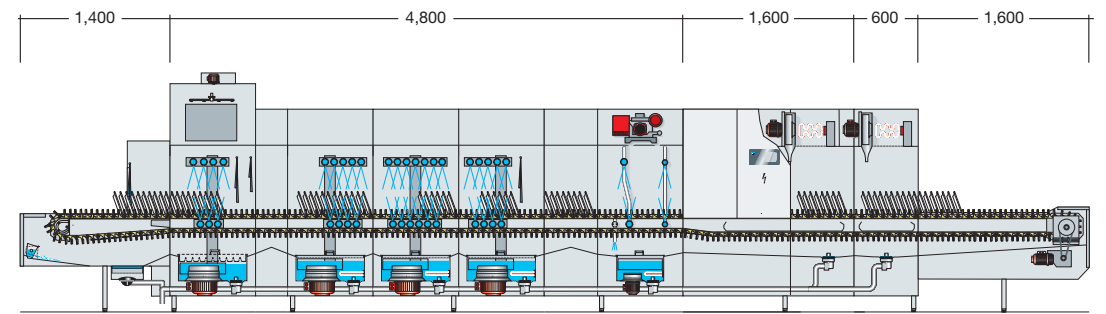
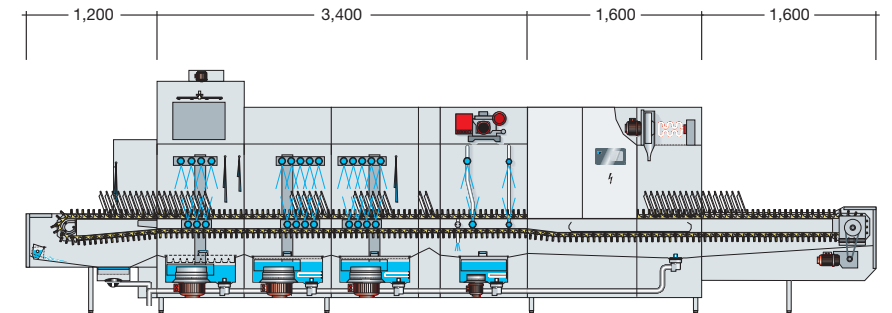
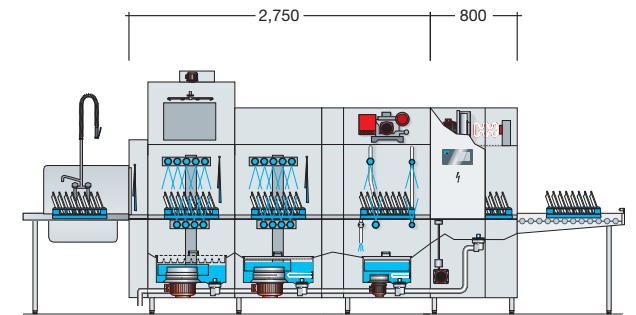
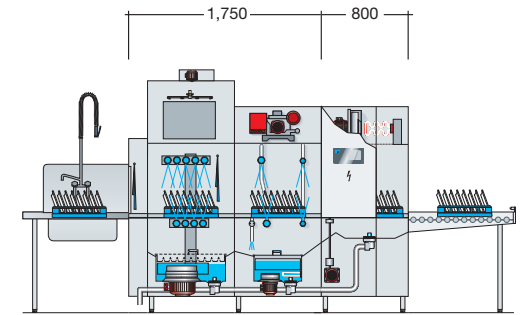
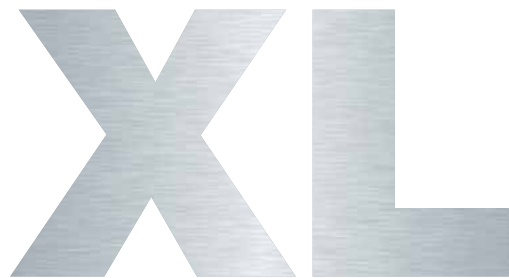
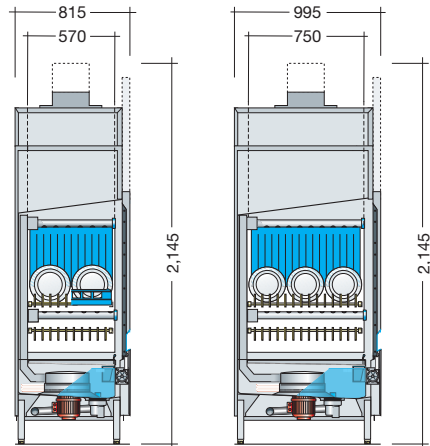
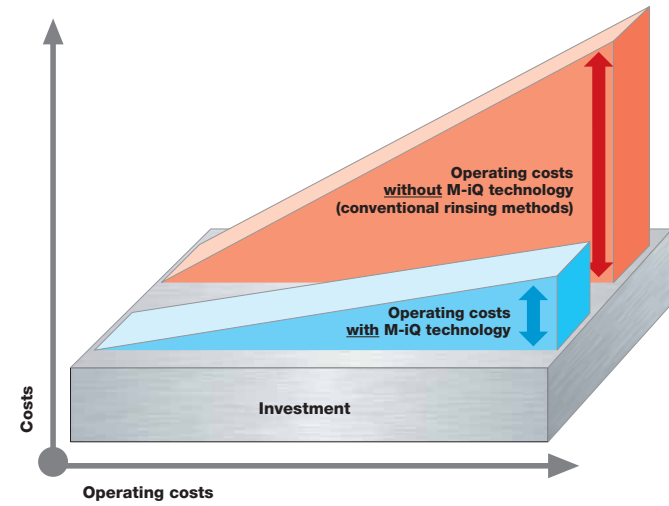

M-iQ PERFORMANCE DATA

M-iQ belt transport standard models		Useful belt width	Dish rate with 2 minutes contact time in compliance with DIN 10510	Transport speed ⁽¹⁾ for 2 minutes contact time in compliance with DIN 10510	Final rinse water consumption	Total electrical connection value (including drying)	Consumption ⁽²⁾ (including drying)	Exhaust air rate ⁽³⁾	Total machine length (including feeding section, drying and discharge section)
Passing height: 465 mm									
B-S54	P6	570	1,730	0.78	165	33.1	25.0	110	4,700
B-S74		750	2,600		215	38.8	33.0		
B-S54	P8	570	1,950	0.88	175	33.1	25.0	110	4,900
B-S74		750	2,930		230	38.8	33.0		
B-M54	V6 P6	570	2,400	1.08	165	33.9	23.5	150	5,500
B-M74		750	3,600		210	39.7	32.0		
B-M54	V8 N02 P8	570	3,060	1.38	165	35.4	24.7	150	6,100
B-M74		750	4,600		215	41.1	32.0		
B-M54	V8 N33 P8	570	3,510	1.58	165	35.4	26.3	150	6,900
B-M74		750	5,260		215	41.9	32.0		
B-L54	V8 N02 P8	570	3,950	1.78	175	41.2	27.9	170	7,800
B-L74		750	5,930		225	46.6	32.0		
B-L54	V8 N24 P8	570	4,400	1.98	180	41.2	29.5	170	8,400
B-L74		750	6,600		240	46.6	33.7		
B-L54	V8 N66 P8	570	5,060	2.28	195	44.7	31.8	170	9,300
B-L74		750	7,600		260	50.2	36.8		
B-XL54	V8 N35 P8	570	5,510	2.48	200	53.6	33.4	190	10,000
B-XL74		750	8,260		260	62.5	38.8		
B-XL54	V8 N66 P8	570	5,950	2.68	205	53.6	35.0	190	10,600
B-XL74		750	8,930		270	62.5	40.8		

M-iQ basket transport standard model		Basket rate with 2 minutes contact time in compliance with DIN 10510	Transport speed ⁽¹⁾ for 2 minutes contact time in compliance with DIN 10510	Final rinse water consumption	Total electrical connection value (including drying)	Consumption ⁽²⁾ (including drying)	Exhaust air rate ⁽³⁾	Machine length (including feeding section, excl. drying resp. exit tunnel and control cabinet)	Machine length without drying cabinet (incl. feeding section and exit tunnel and control cabinet)
Passing height: 465 mm Useful width: 570 mm Basket size: 500 x 500 mm									
K-S54	P6	95	0.78	165	33.0	25.0	110	1,550	2,050
K-S54	P8	105	0.88	175	33.0	25.0	110	1,750	2,250
K-S54	N02 P8	115	0.98	170	33.0	25.0	110	1,950	2,450
K-M54	V6 P6	130	1.08	165	33.8	23.5	150	2,150	2,650
K-M54	V8 P8	155	1.28	165	35.3	23.9	150	2,550	3,050
K-M54	V8 N02 P8	165	1.38	165	35.3	24.7	150	2,750	3,250
K-M54	V8 N22 P8	175	1.48	165	35.3	25.5	150	2,950	3,450
K-M54	V8 N33 P8	190	1.58	165	35.3	26.3	150	3,150	3,650
K-M54	V8 N44 P8	200	1.68	170	35.3	27.1	150	3,350	3,850
K-L54	V8 N02 P8	215	1.78	175	41.0	27.9	170	3,550	4,050
K-L54	V8 N22 P8	225	1.88	180	41.0	28.7	170	3,750	4,250

⁽¹⁾ The other two transport speeds can be set on-site individually between DIN -10% and up to DIN +35%, depending on the level of food soil, drying time, type of dishware etc.

⁽²⁾ This is an average value based on an sample tray set and operating mode. Building-relevant data is to be derived from an individual evaluation of economic efficiency.

⁽³⁾ The exhaust temperature depends on the fresh water supply temperature. With a fresh water supply temperature of max. 12 °C exhaust conditions of approx. 22 °C at 90 % rel. humidity result.

THE M-iQ MODULES / COMPONENTS

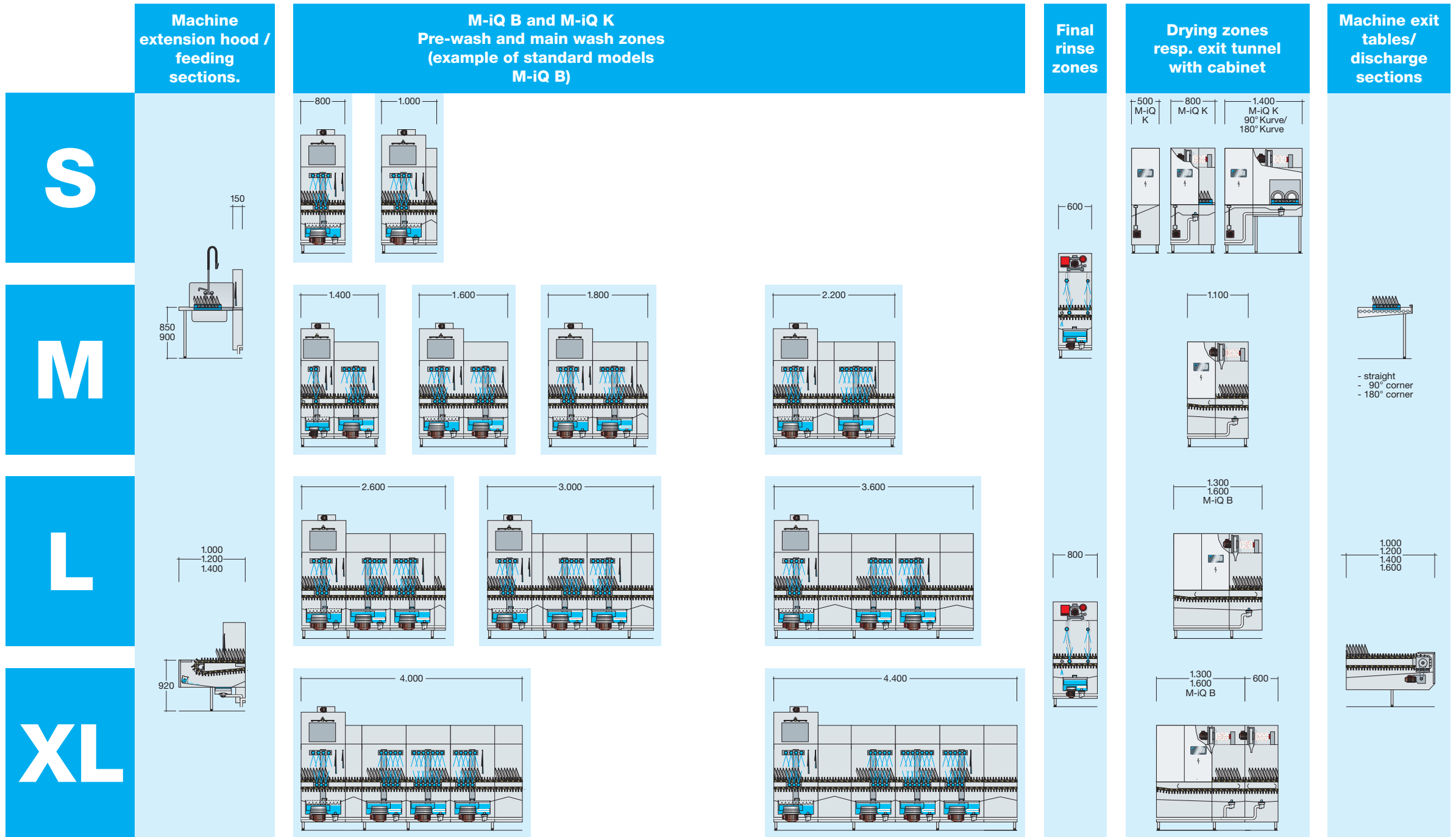



The clean solution

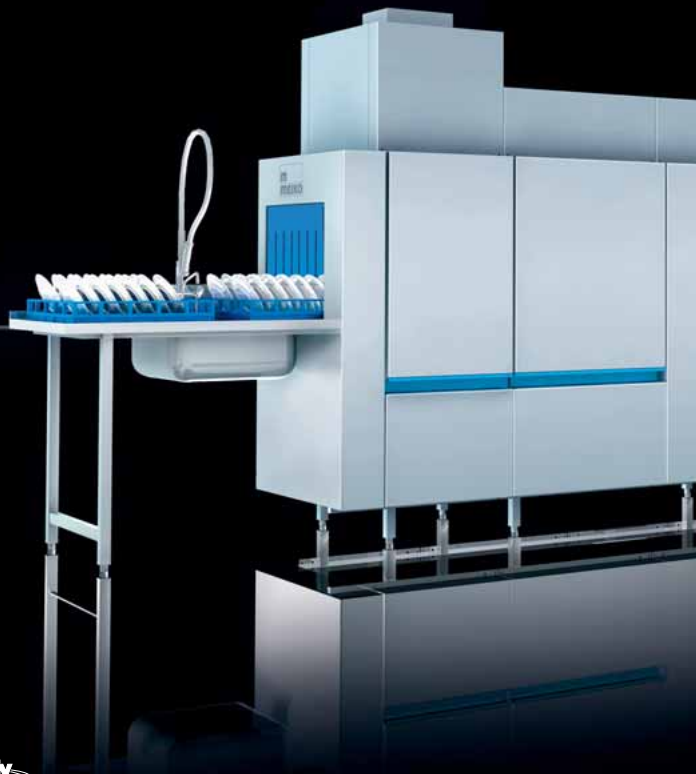

MEIKO Maschinenbau GmbH & Co. KG

Englerstraße 3
77652 Offenburg

Germany

Tel. +49 (0)781 / 203-0

Fax +49 (0)781 / 203-1121

www.meiko.de

info@meiko.de

260.030.01.06.10/GB/KD/7000



DIN 10510

We reserve the right to make modifications
as part of future developments.